

VIDEO  
ENTRY PANEL

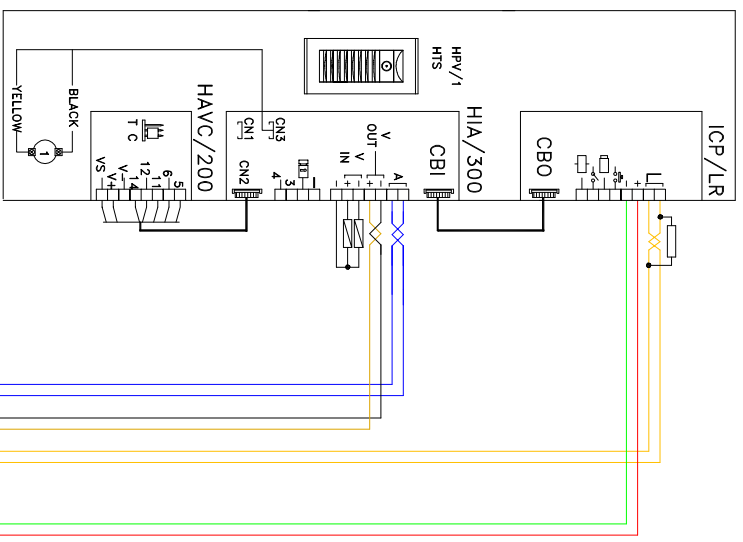

SEE THE HIA/300 INSTRUCTIONS FOR  
COLOUR CODE TO HAVC/200 TERMINALS

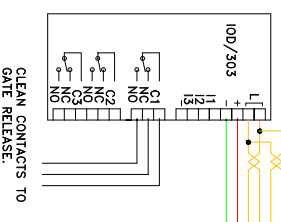

1. IT IS VITAL THAT THE CLOSING RESISTANCES SHOWN ON THE DRAWING AS 56R & 120R ARE CONNECTED AS INDICATED.

2. THE TWISTED PAIRS MUST NOT BE UNTWISTED TO SIMPLY INSERTION INTO TERMINALS. KEEP THEM TWISTED TOGETHER ALL THE WAY INTO THE TERMINALS

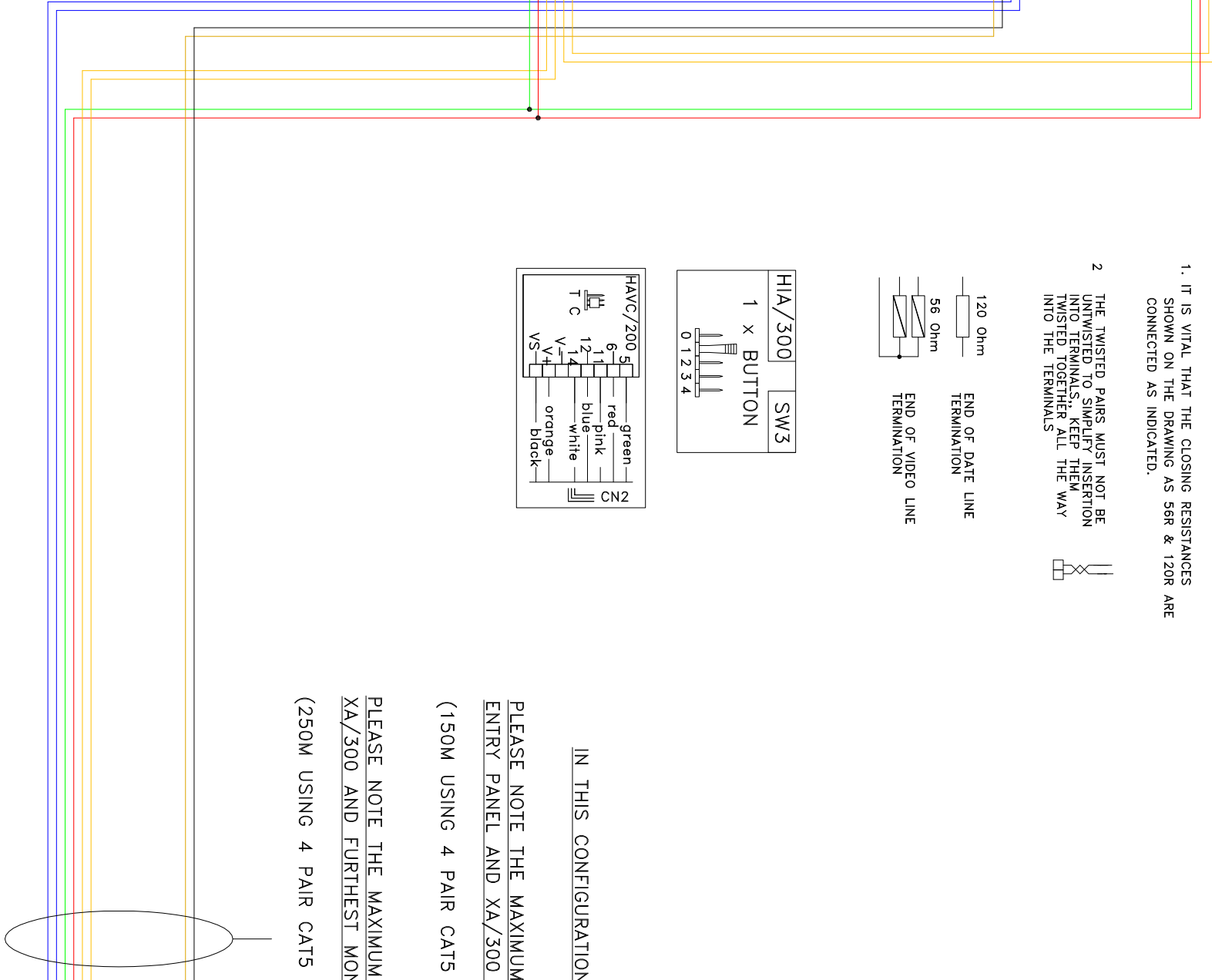
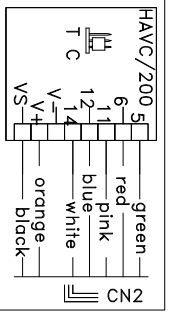
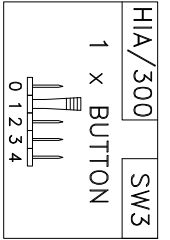
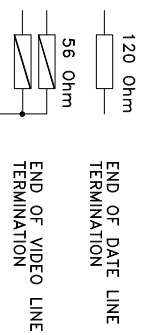

IN THIS CONFIGURATION SHOWN

PLEASE NOTE THE MAXIMUM DISTANCE BETWEEN ENTRY PANEL AND XA/300 CANNOT EXCEED

(150M USING 4 PAIR CAT5 + 2 CORES @ 1.0MMSQ)

PLEASE NOTE THE MAXIMUM DISTANCE BETWEEN XA/300 AND FURTHEST MONITOR CANNOT EXCEED

(250M USING 4 PAIR CAT5 + 2 CORES @ 1.0MMSQ),

CAT 5 +  
2 CORES @ 1.0MMSQ (FOR 50M)

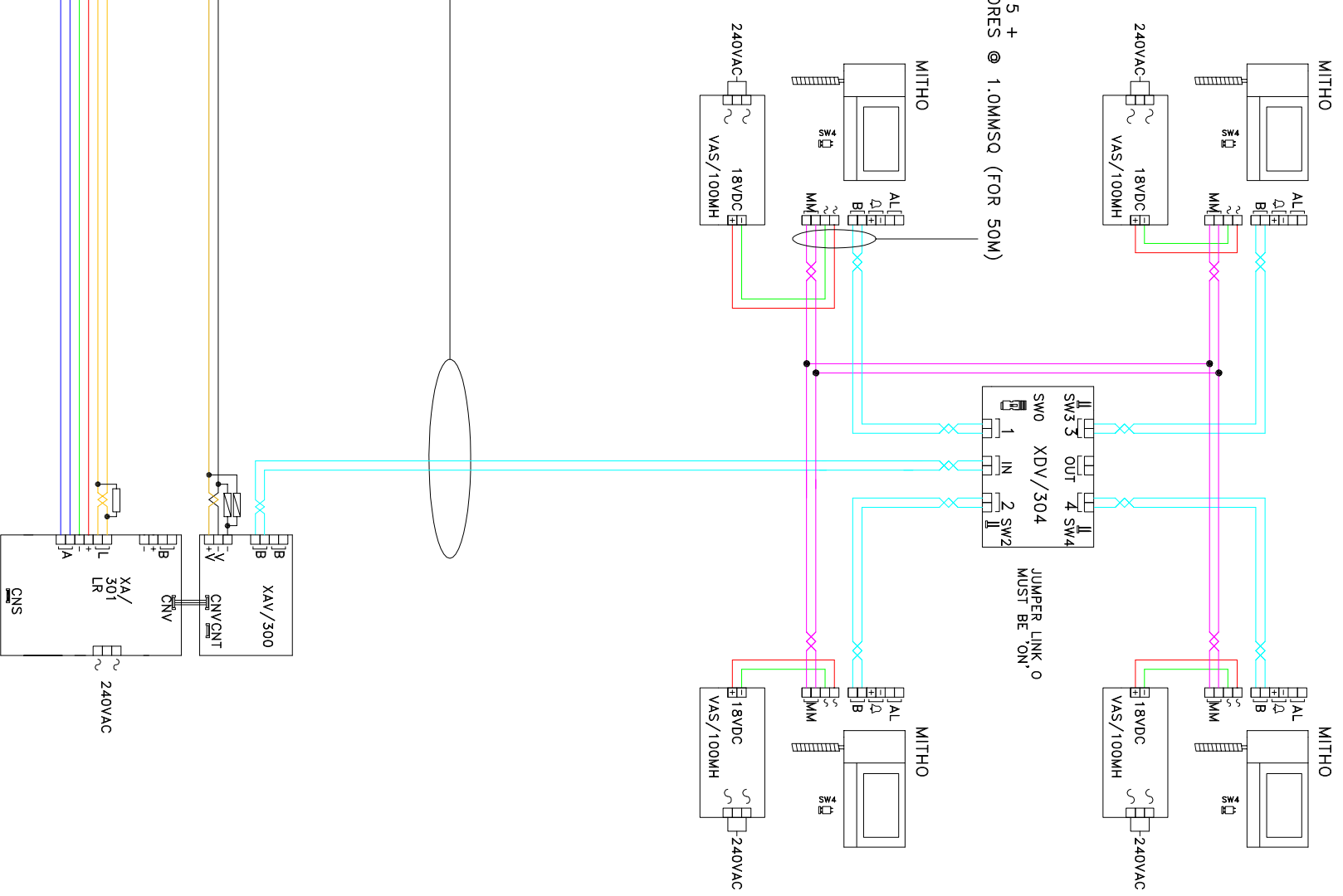

BPT (UK) LTD. HERTS. ENGLAND	PREPARED FOR	DATE: 24/09/08	DRAWN:RC
	INSTALLER INFORMATION	REVISED:	
DRAWING TITLE:	1 X 1 BUTTON TARGHA VIDEO ENTRY PANEL (DIST. UPTO 150M) & 4 MITHO MONITORS		DRAWING No: C-1T1Q4C